

# MULTI-PURPOSE MIRRORS



## 3 DIRECTIONS

### PRODUCT CODE

P.A.S.<sup>®</sup> optics ▶ Code 9080

### GUARANTEE



> Unbreakable > light > unalterable > Anti-UV treated  
> 5 year guarantee.



### TECHNICAL SPECIFICATIONS

- > Lens: PAS optics
- > Dimensions: Ø 774 mm
- > Packaging dimensions: 870 x 380 x 910 mm
- > Gross weight: 9.6 kg
- > Angle of convexity: for a field of vision of approximately 180° used at junctions where users are coming from 3 different directions
- > Maximum distance between the mirror and viewer: approx. 8m
- > Fixing kit supplied
- > Full guarantee (mirror, frame and fixings)\*
- > Manufactured in France
- > 100% recyclable

### FIXING KIT DIAGRAM

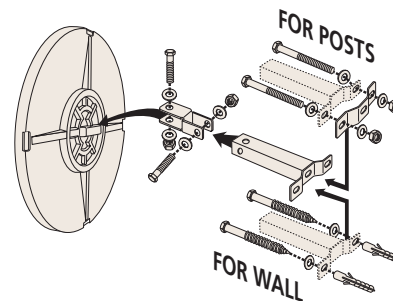

Supplied complete with bolts and brackets kit, adaptable for walls or for posts 60 to 90mm in diameter. Kit is robust, tested to withstand winds of up to 183km/h. Easy to install, allowing precise adjustment of the position of the mirror.

### DIMENSIONS

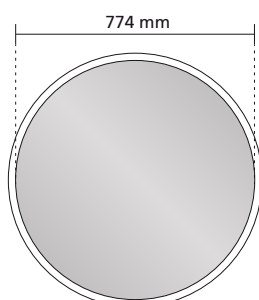

### RECOMMENDED INSTALLATION

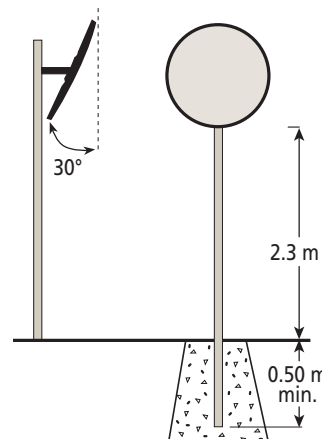

[www.vialux.eu](http://www.vialux.eu)

\*Under normal operating conditions.